

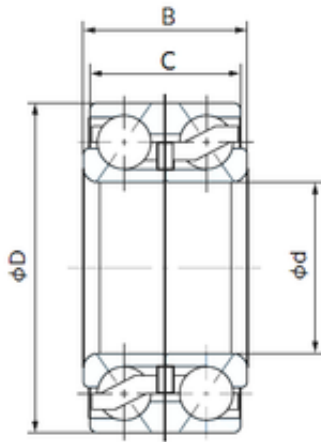

NTN Bearing Manufacturing of Canada



32 mm x 72 mm x 45 mm NACHI
32BVV07-8G angular contact ball bearings

Bearing No. 32BVV07-8G

Size	32x72x45 mm
Bore Diameter	32 mm
Outer Diameter	72 mm
Width	45 mm
d	32 mm
D	72 mm
B	45 mm

32BVV07-8G Bearing 2D drawings and 3D CAD models